

DO-IT-YOURSELF

DIRECTIONAL COUPLERS



Typical Performance Data - TCD-13-4-75

Frequency (MHz)	Insertion					
	Loss (dB)	CPL (dB)	DIRECTIVITY (dB)	RL-IN (dB)	RL-OUT (dB)	RL-CPL (dB)
5	0.96	13.23	22.93	18.39	22.11	20.63
100	0.8	13.07	21.46	21.56	29.75	23.23
200	0.82	13.07	19.9	22.09	29.67	22.99
300	0.84	13.06	18.25	22.15	27.88	22.67
400	0.86	13.03	16.68	21.58	24.86	22.04
500	0.86	12.96	15.34	20.44	22.11	21.08
600	0.87	12.88	14.27	19.08	19.99	20.15
700	0.91	12.82	13.42	17.97	18.61	19.42
800	0.93	12.73	12.75	17.33	17.64	18.67
1000	1.02	12.56	11.88	17.83	17.63	17.78

CASE STYLE DRAWINGS & DIMENSIONS (INCH)
CASE STYLE DB714

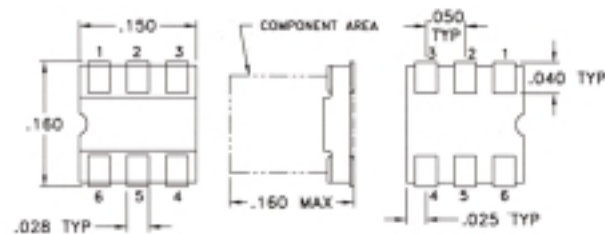

WT GRAMS: .15

SUGGESTED PCB LAYOUT FOR TCD COUPLERS

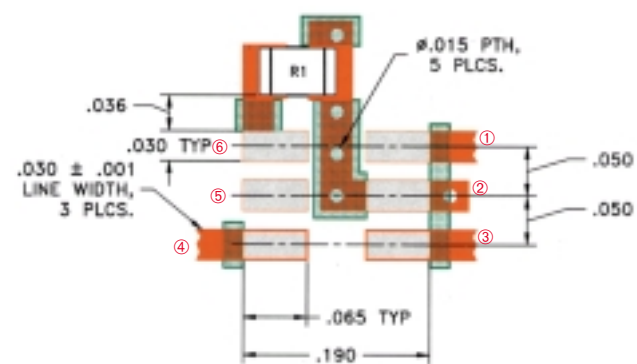

- DENOTES METALLIZATION
- DENOTES SOLDER MASK
- DENOTES METALLIZATION FOR DEVICE SOLDERING

RECOMMENDED MATERIAL: ROGERS R04350, DIELECTRIC THICKNESS: .030 ± .002
COPPER: 1/2 OZ. EACH SIDE
RESISTOR R1: 0805 SIZE, REFER TO TABLE 1 FOR VALUE.

Fig. 7

PIN CONFIGURATION

PORT	
INPUT	3
OUTPUT	4
COUPLED	1
GND	2
50/75Ω TERM (EXTERNAL)	6
NOT USED	5

MAXIMUM RATINGS

OPERATING TEMPERATURE	-20°C to 85°C
STORAGE TEMPERATURE	-55°C to 100°C

DIRECTIONAL COUPLERS



DO-IT-YOURSELF





Introduction

Ever expanding applications of RF and Microwaves for Wireless and Cable applications have revived the development efforts of components at these frequencies. There is a continuing demand to reduce the cost and increase the performance and quality at the same time. Mini-Circuits is working to satisfy these goals and has introduced a new Directional Coupler series to satisfy the demands of the market. These couplers are designed to need only commercially available low-cost off-the-shelf chip resistors as external components, and are designed for automated manufacturing to achieve low overall cost.

What Constitutes a Directional Coupler

Fig 1 is the block schematic of a Directional Coupler. The heart of the coupler is supplied by Mini-Circuits as a component. When used with one external chip component, a resistor R₁, a complete coupler is realized. Mini-Circuits has released a series of couplers for both 50 and 75 ohm applications. These couplers have prefix "TCD" in their model number.

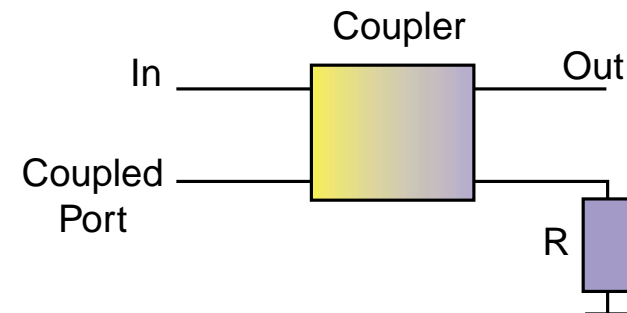

Fig.1 Block Schematic of a Directional Coupler

Construction of the "TCD" device

TCD-series couplers use one magnetic core transmission line transformer to realize a directional coupler. The base of the device is plastic with embedded leads, which makes the construction very rugged. The leads are solder plated for excellent solderability. All connections from the transformers to the header are made by welding. This helps to ensure preciseness of the assembly, with resulting high performance repeatability, as well as preventing any disconnection during reflow.

Performance of the Coupler

Mini-Circuits has introduced 9 couplers covering the frequency range of 5 to 1000 MHz. TCD-13-4 for example, is a 13 dB coupler designed for 50 ohms, and TCD-13-4-75 is a 13 dB coupler with 75 ohm characteristic impedance. Fig 2 is a photograph of the coupler and Table 1 gives the specifications. Also shown in Table 1 are the specifications for couplers having other coupling values. Fig 3 shows the insertion loss of TCD-13-4-75. The insertion loss of the coupler is typically 0.9 dB over the band. Fig 4 shows the directivity vs. frequency, which is typically 15 dB. Fig 5 shows coupling vs. frequency, which is typically 13 dB. Fig 6 shows return loss vs. frequency at all three ports, which is typically 20 dB (VSWR, 1.22:1). Circuit board layout plays an important part in the performance of the coupler. In order to minimize parasitic effects, the suggested layout shown in Fig 7 should be used. This series needs only an external resistor of 0805 size. The chip resistor should have a nominal value of 75 and 50 ohms for TCD-13-4-75 and TCD-13-4 respectively. Actual data for other couplers shown in table 1 can be viewed instantly at <http://www.minicircuits.com>.



Fig. 2

Conclusion

Nine couplers have been introduced to operate over 5-1000 MHz. Due to all-welded connections the couplers are very rugged. The product has been designed to be fabricated in automated set-ups which helps lower the cost. Further cost reduction is obtained by designing the unit to work with a low-cost off-the-shelf chip resistor used as external component. These units are designed for automated pick and place manufacturing.

ELECTRICAL SPECIFICATIONS Table 1

MODEL NO.	FREQ. RANGE (MHz) f _L -f _U	COUPLING (dB)		MAINLINE LOSS (dB)			DIRECTIVITY (dB)			RESISTOR, R1	VSWR (:1)	POWER INPUT, W		CASE STYLE	Price \$ea. Qty. (10-49)						
		Nom.	Max Flatness	L Typ.	M Typ.	U Typ.	L Typ.	M Typ.	U Typ.			L Max.	MU Max.								
TCD-9-1W	5-750	8.9±0.5	±0.5	1.2	2.1	1.2	1.8	1.5	1.9	21	17	17	10	15	-	50	1.30	0.5	1	DB714	5.95
■ TCD-9-1W-75	5-500	8.9±0.5	±0.5	1.3	2.1	1.2	1.8	1.3	1.9	21	17	17	10	12	-	75	1.30	0.5	1	DB714	5.95
TCD-10-1W	10-750	10.3±0.5	±0.8	1.3	2.1	1.2	1.6	1.4	2.0	22	17	18	14	15	-	50	1.30	0.5	1	DB714	5.95
■ TCD-10-1W-75	10-750	10.5±0.5	±0.7	1.6	2.1	1.4	1.9	1.5	2.0	22	17	18	14	14	-	75	1.30	0.5	1	DB714	5.95
TCD-13-4	5-1000	13.0±0.5	±0.6	0.7	1.3	0.7	1.3	0.8	1.5	21	17	18	12	15	-	50	1.20	0.5	1	DB714	5.95
■ TCD-13-4-75	5-1000	13.0±0.5	±0.9	1.0	1.8	0.8	1.3	1.1	1.5	22	17	15	-	12	-	75	1.20	0.5	1	DB714	5.95
TCD-18-4	5-1000	17.9±0.5	±0.6	0.7	1.3	0.7	1.1	1.0	1.4	22	11	20	15	18	-	50	1.20	1	1	DB714	5.95
■ TCD-18-4-75	5-1000	18.0±0.5	±0.9	0.9	1.3	0.7	1.2	0.8	1.3	20	15	22	15	18	-	75	1.20	1	1	DB714	5.95
TCD-20-4	5-1000	20.0±0.5	±0.8	0.3	0.9	0.4	0.8	0.7	1.1	20	11	21	15	15	-	50	1.20	1	1	DB714	5.95

■ Denotes 75 ohm model L=low range [f_L to 10 f_L] M=mid range [10 f_L to f_U/2] U=upper range [f_U/2 to f_U]

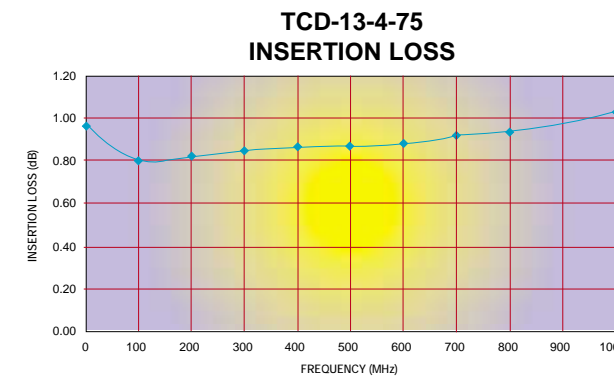

Fig. 3

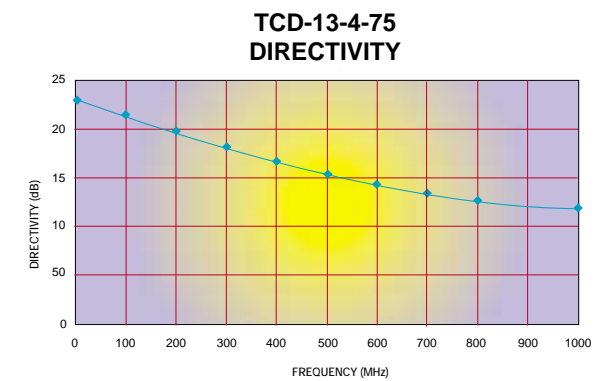

Fig. 4

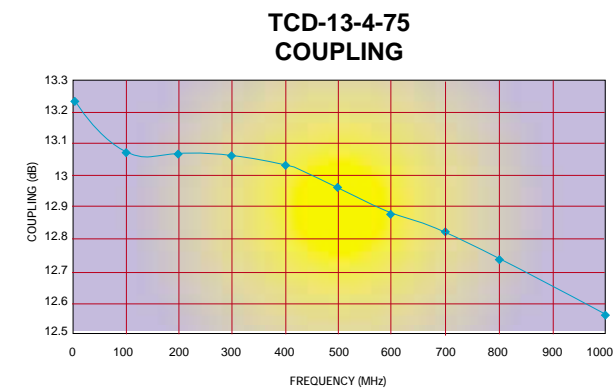

Fig. 5

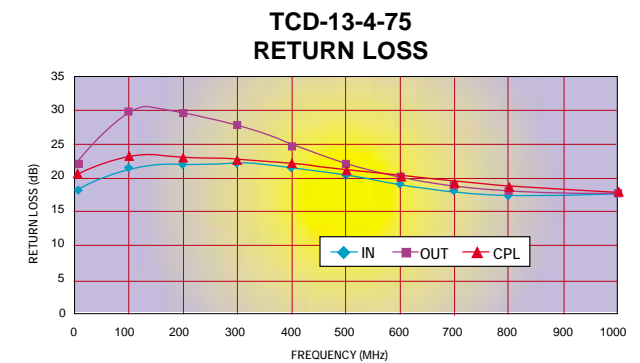

Fig. 6

